



Processing observations for NWP: current practice and future plans

ECMWF Met Operational Systems Workshop 2-6 Nov 2009

Rick Rawlins

Met Office UK



Outline of talk

- Introduction: requirements
- Current systems for processing observations
- Examples of monitoring
- Problems with current practice
- Future plans
- Summary

Acknowledgements:

Brett Candy, Bruce Ingleby, Adam Maycock, Colin Parrett, Mike Rennie, Adrian Semple, Mike Thurlow, Bruce Wright



Requirements for observation processing

- Initialising model forecasts
 - Ingestion of observations into data assimilation
 - Creation of perturbations for ensemble forecasts
- Monitoring quality of observations
- Feed back quality control information of observations for:
 - Verification of model forecasts and products
 - Downstream products and services
 - [Climatology aspects handled outside NWP but note move to 'SEAMLESS prediction systems']



Observations in Met Office (global) model

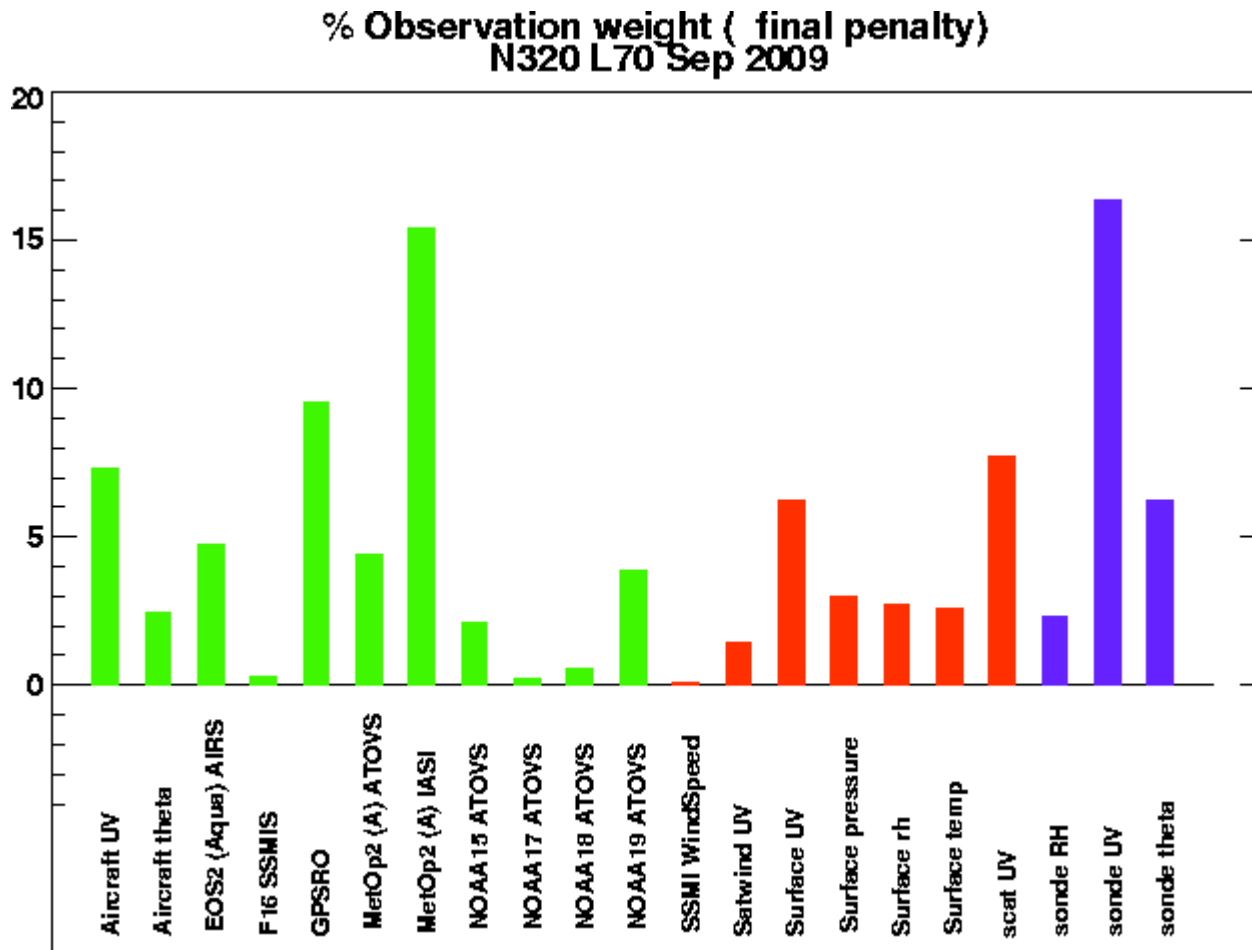



Main steps in the assimilation process

- 1. Receipt of observation data
 - Conversion of units
 - Re-mapping (satellite data)
- 2. Quality control of data
 - Reject lists
 - Background and buddy checking, etc
- 3. Data thinning
 - In space and time
- 4. Variational assimilation

Observation processing (schematic)

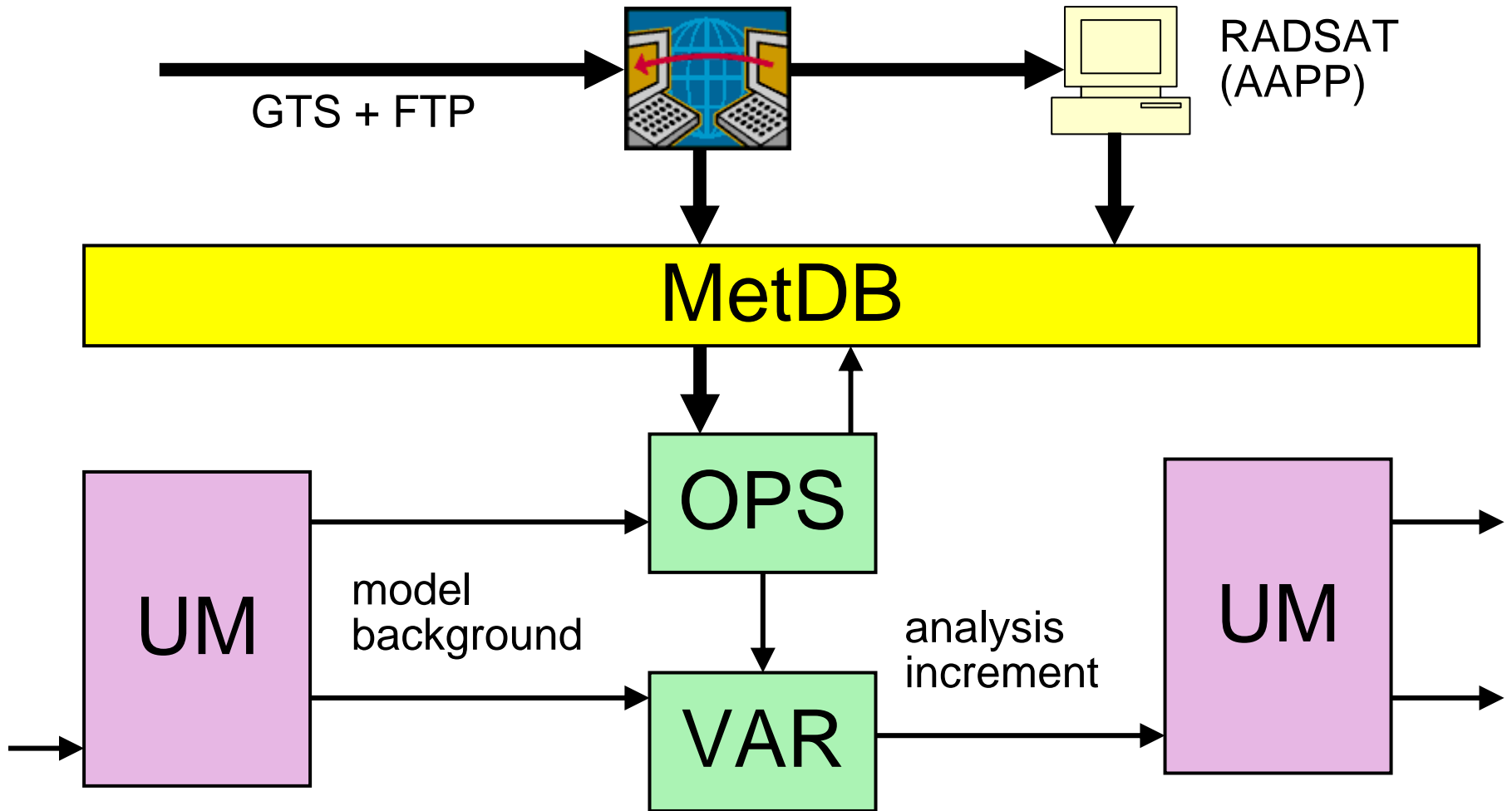

Observation processing (schematic)

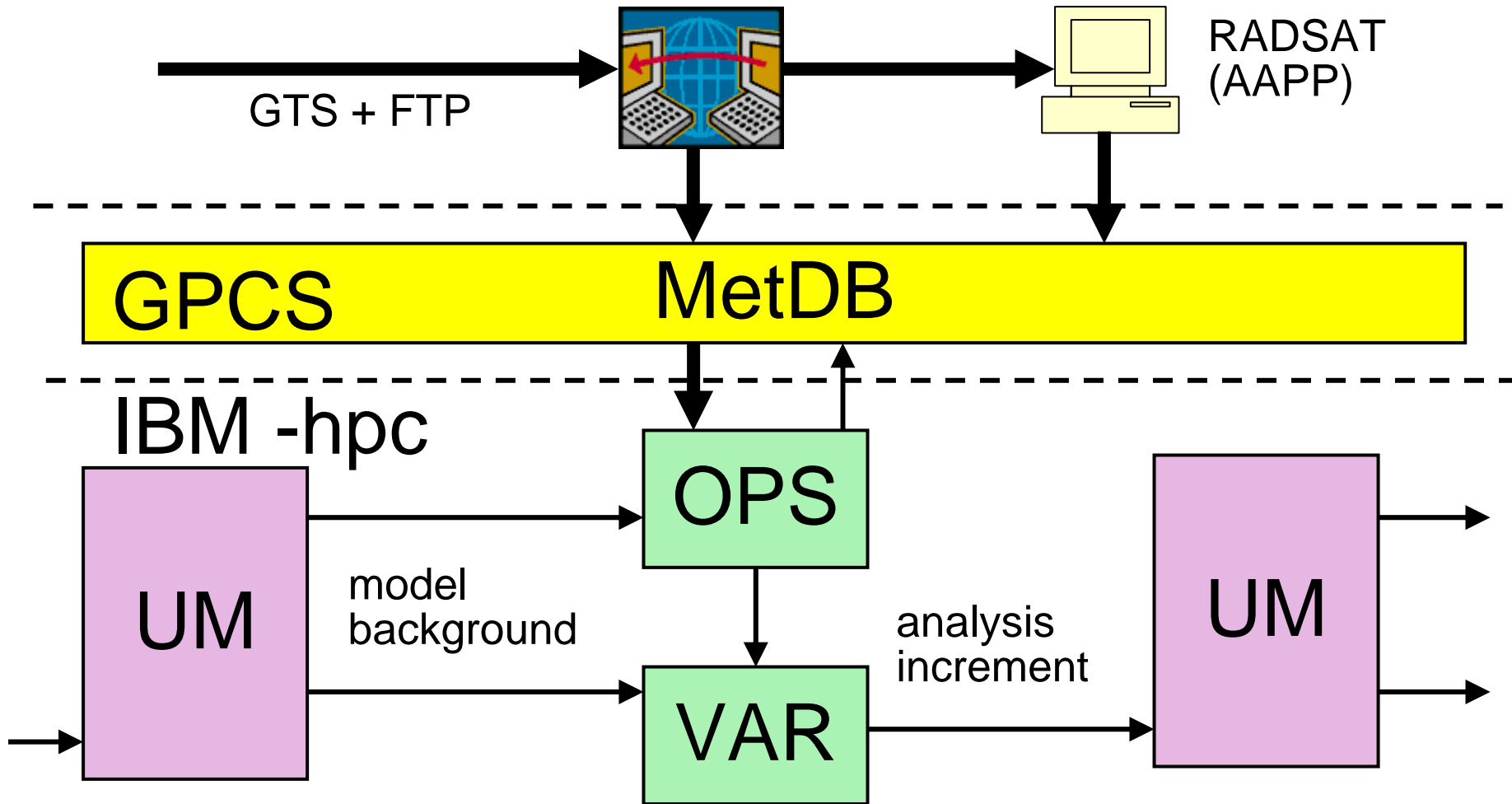



Observation processing (schematic)

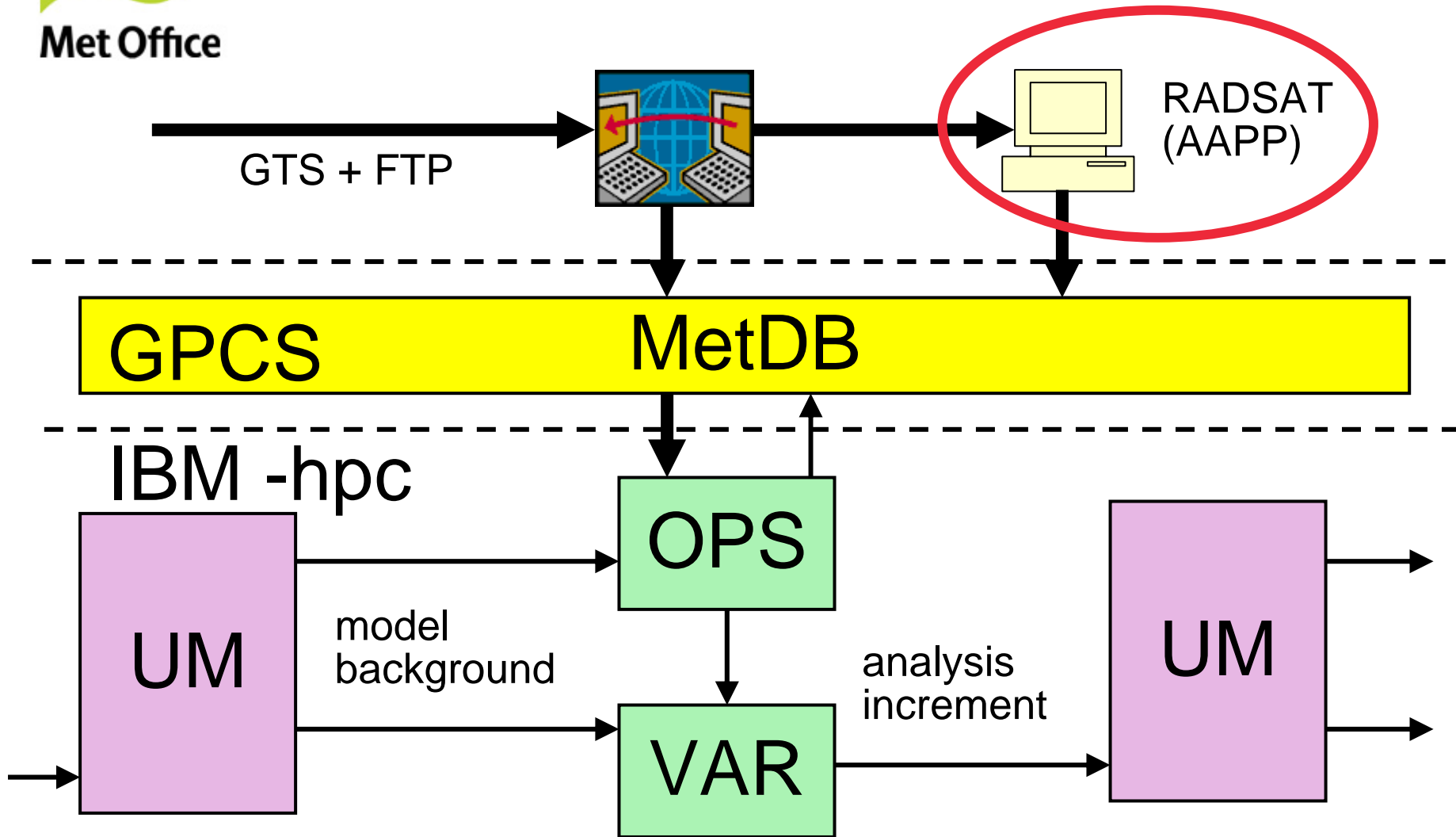



Example of Data Receipt - ATOVS

Met Office Global datasets

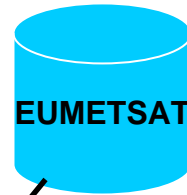
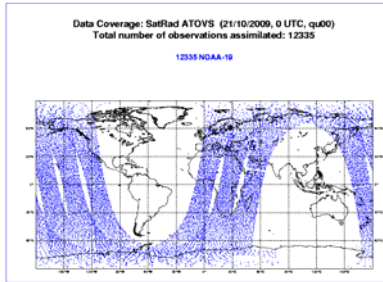

MetOp, NOAAs (1c)

MetOp, NOAAs (1b)

Antenna Temperature correction (AAPP)

Map to HIRS Grid 1c to 1d (AAPP)

Met Office Data Base (MetDB)

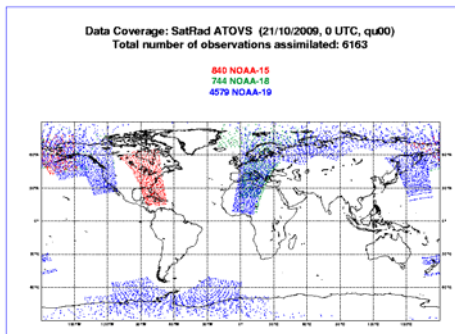

Local Ground Station datasets

- Three data sources for robustness
- RARS data useful in 'filling in' for late global data. Consistency between global and local data routinely monitored
- AAPP (ATOVS and AVHRR Processing Package), is used to perform antenna correction and mapping of instruments to a single grid

Observation processing (schematic)

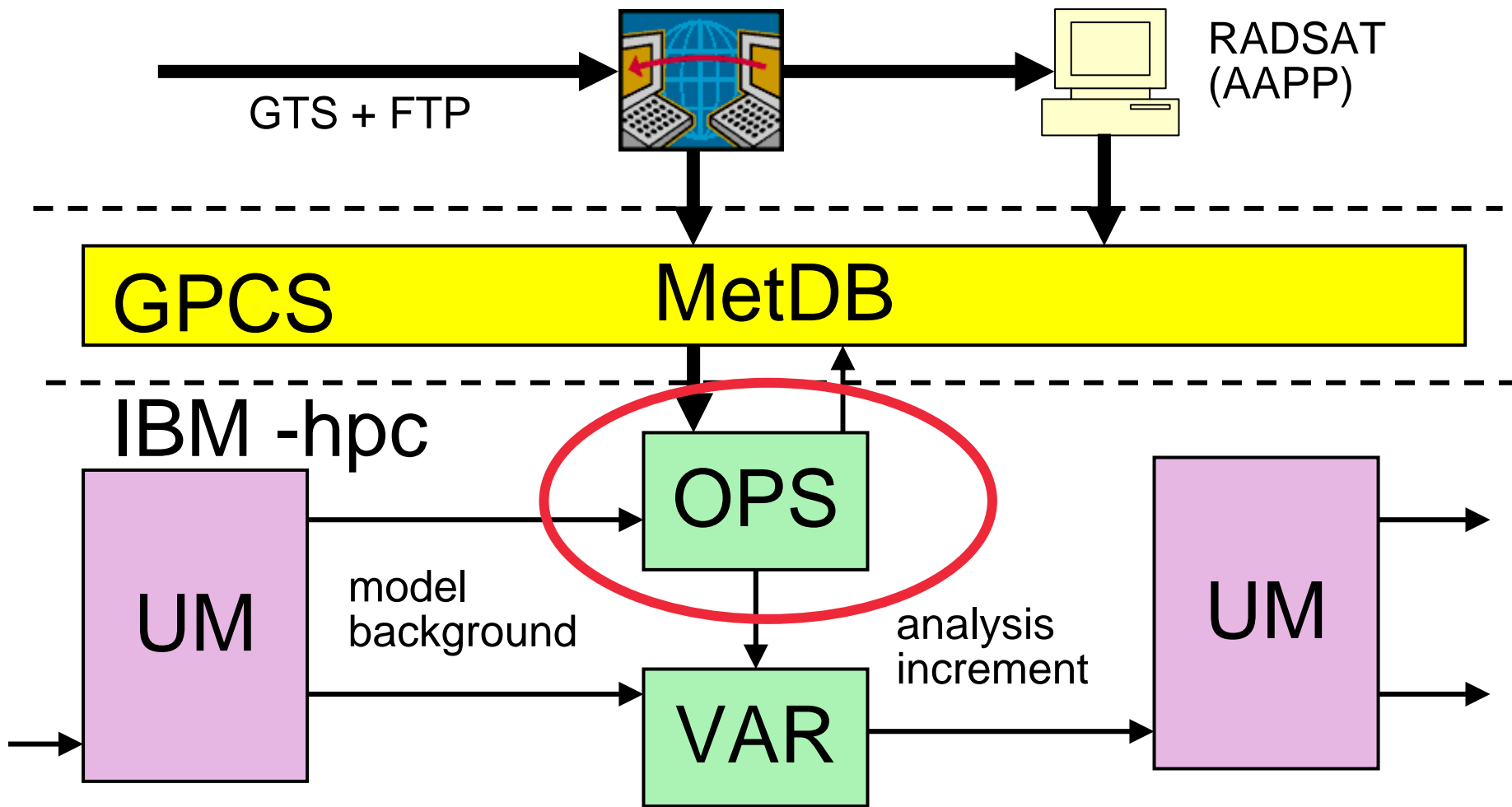

Example of Pre-processing: ATOVS (within OPS)

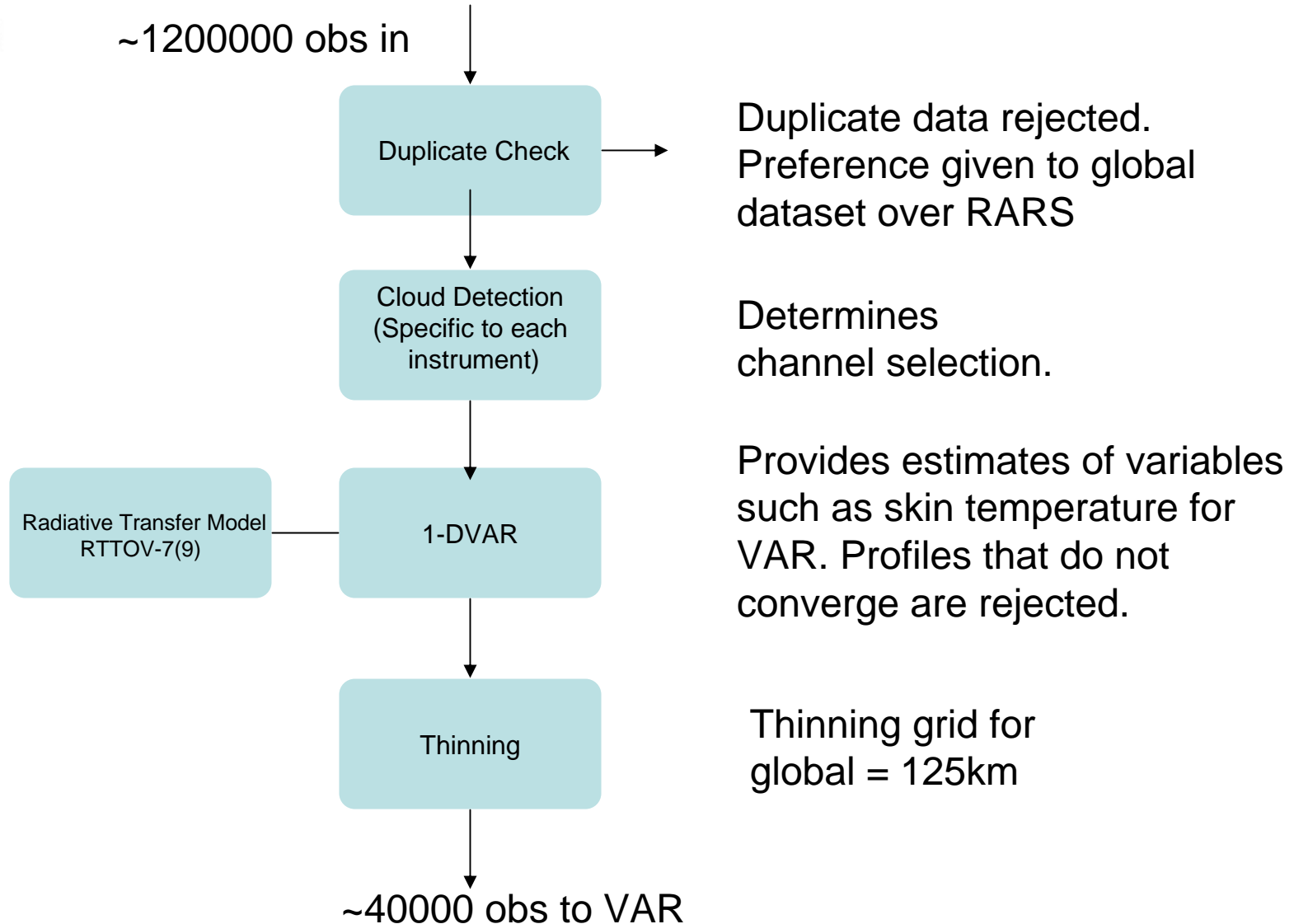



Diagnosing performance of data assimilation

- Verification: T+0 diagnostics
- Assimilation increments and forecast evaluation
- Statistics of assimilation: penalties, iteration count, etc



Diagnosing performance of data assimilation

- Verification: T+0 diagnostics
- Assimilation increments and forecast evaluation
- Statistics of assimilation: penalties, iteration count, etc
- Monitoring observations: eg o-b, timeliness, data coverage
 - Mergeback model/observations: routine + investigations
 - Real time monitoring
 - Satellite: radiance/scatterometer/GPSRO monitoring

Corrupted US windprofiler data April 2008

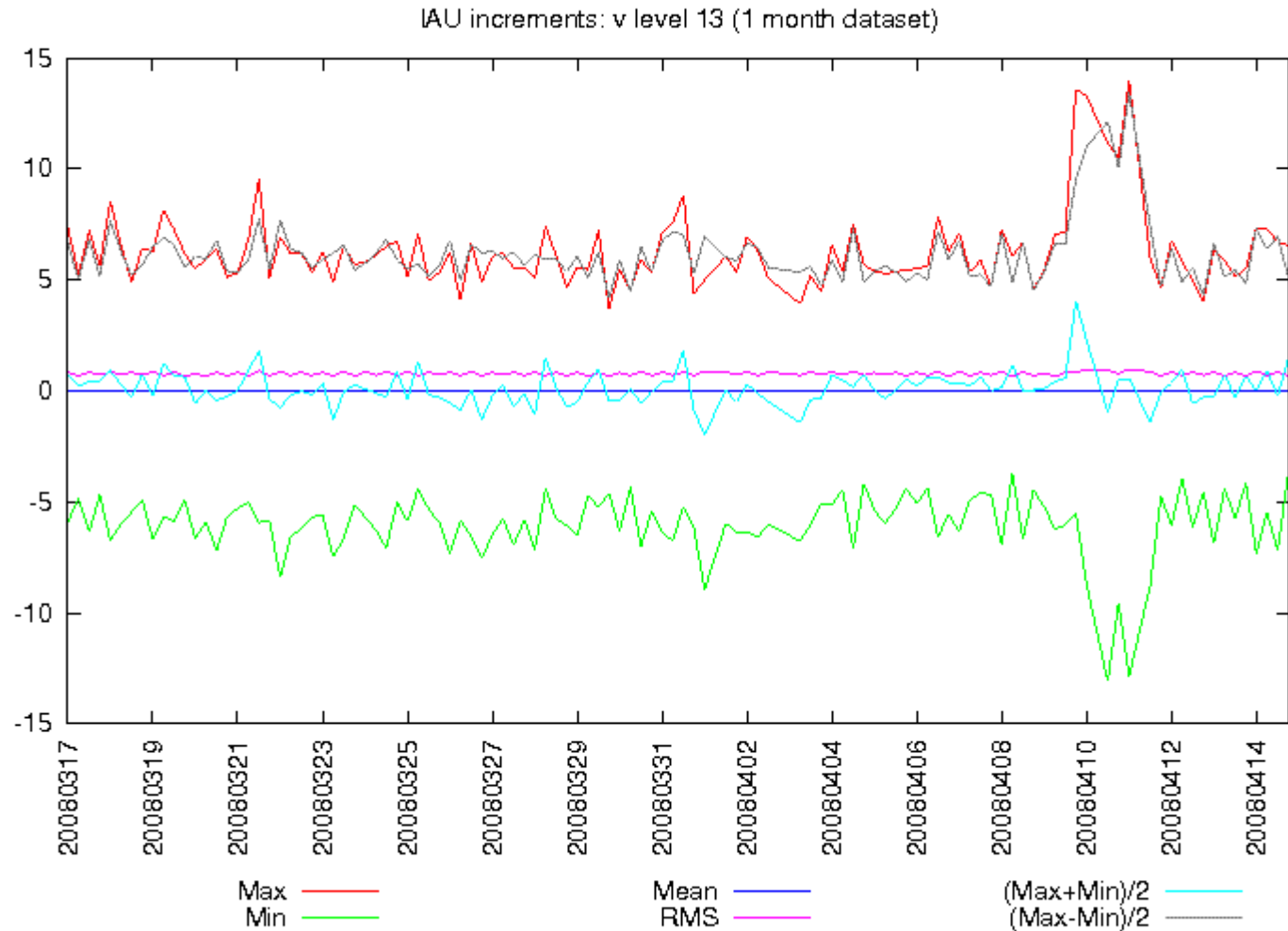

Corrupted US windprofiler data April 2008

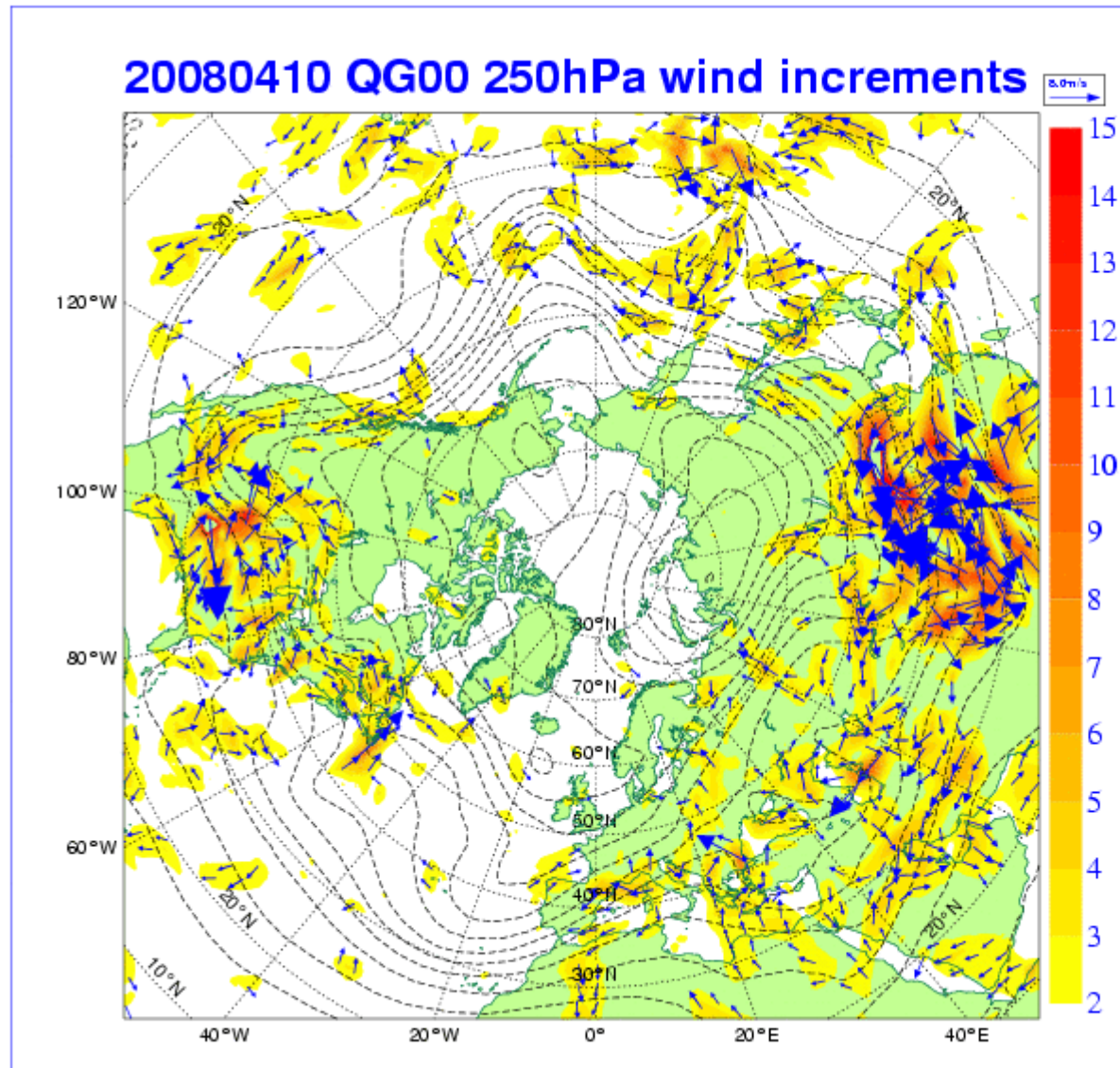



Outline of talk

- Introduction: requirements
- Current systems for processing observations
- **Examples of monitoring**
- Problems with current practice
- Future plans
- Summary



Wind speed O-B June 2006

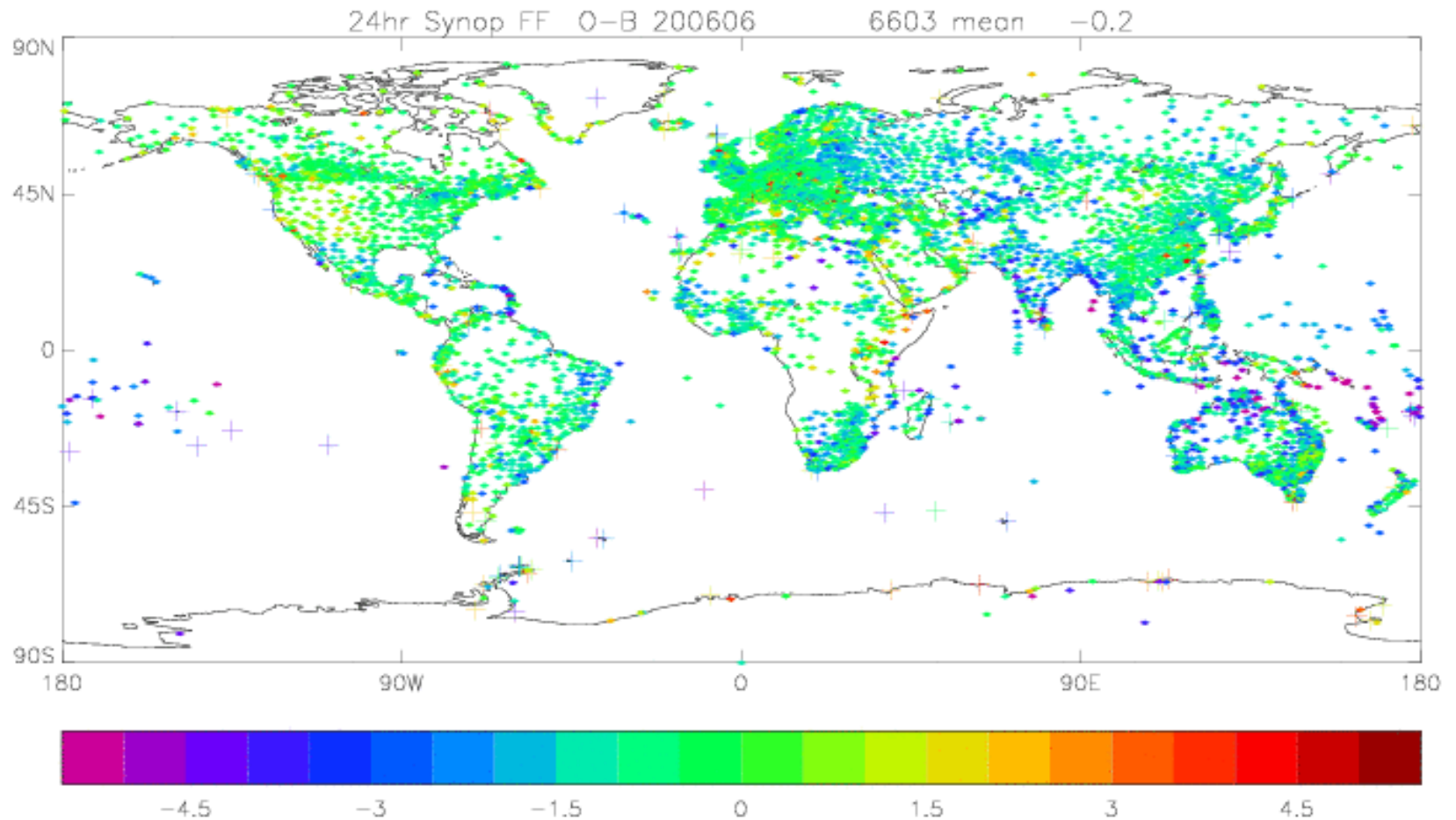



O-B wind speed, Dec Night

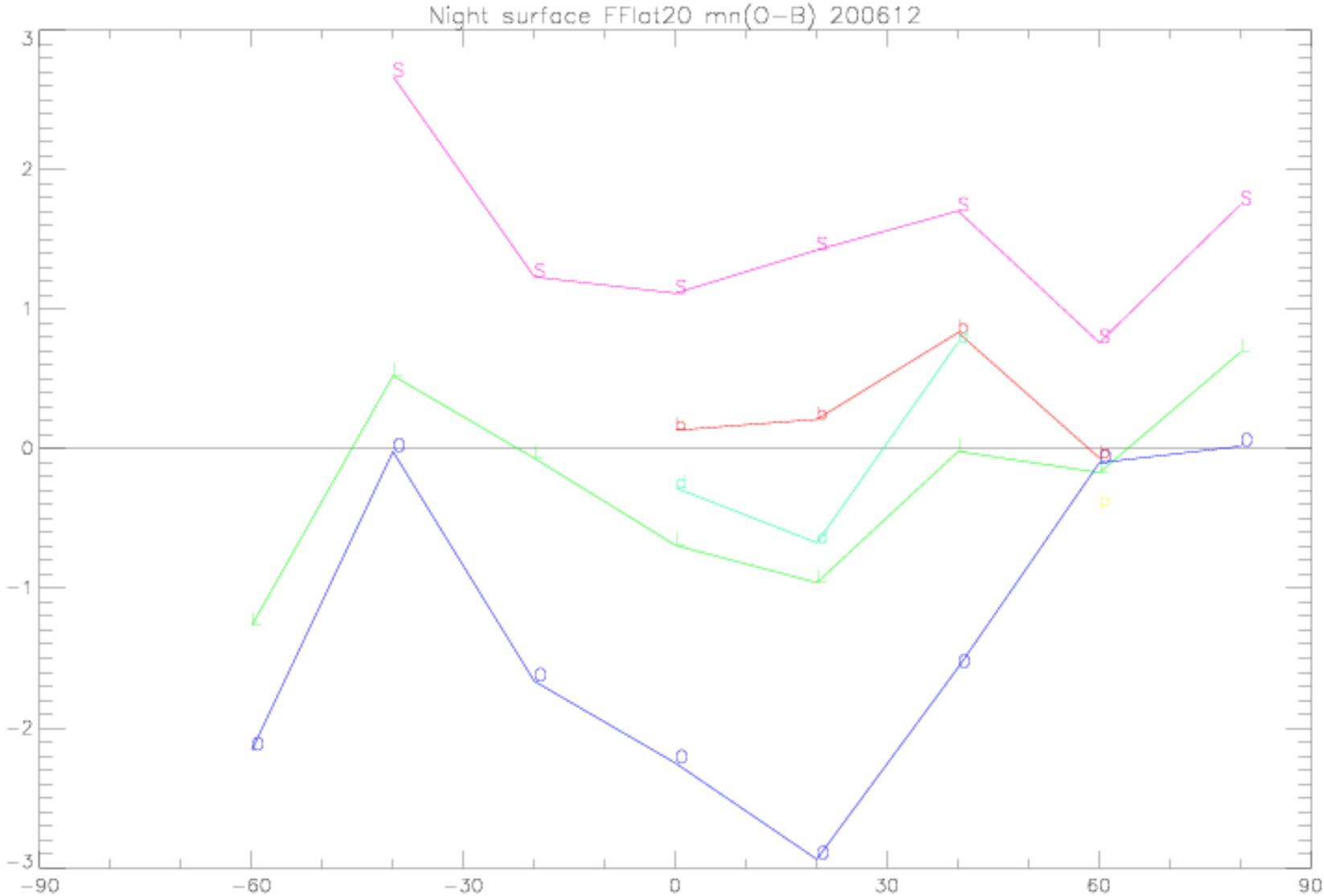

Rounding of ship winds

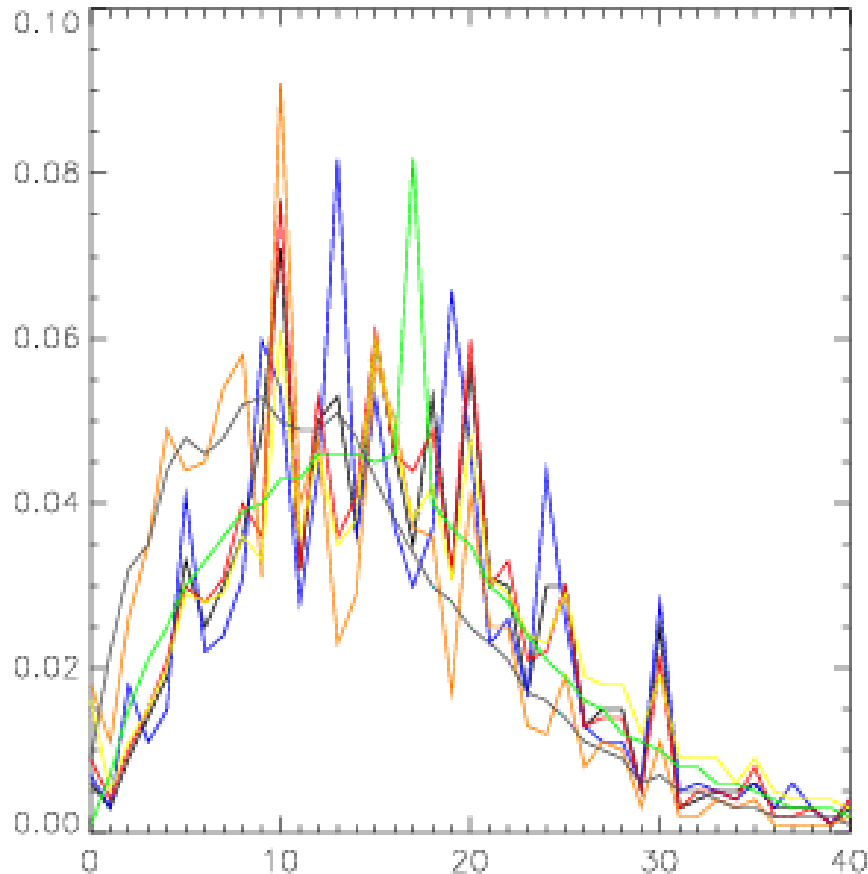

Unadjusted speeds (in knots) by country

Rounding to nearest 5 or 10 – auto better

Too many calm winds? – worse for Synops, anemometer friction etc

Resolution (1 knot or 1 m/s) a bit coarse for Synops

Plot of occultation and radiosonde positions for most recent OPS run

Data from file: /var/tmp/GPSRO_mon/2009102606_ref.no.gz

Number of occultations: 514

Number of radiosondes: 29

- no data rejection ▼
- convergence fail □
- cost function fail +
- obs-yoals fail ◇
- miss data fail *
- O-B fail ▲
- NN ref fail x

GRAS DMI
 No obs: 170
 No OK: 154
 Conv 0.0 0.0
 Cost 0.0 0.0
 O-y 0.0 0.0
 Miss 0.0 0.0
 O-B 1.2 0.0
 NN ref 8.2 2.2 [14]

Cosmic1 UCAR
 No obs: 96
 No OK: 96
 Conv 0.0 0.0
 Cost 0.0 0.0
 O-y 1.0 0.0
 Miss 0.3 0.0
 O-B 1.1 0.0
 NN ref 2.1 0.0 [2]

Cosmic4 UCAR
 No obs: 99
 No OK: 99
 Conv 0.0 0.0
 Cost 0.0 0.0
 O-y 0.0 0.0
 Miss 0.0 0.0
 O-B 1.1 0.0
 NN ref 1.1 0.0 [1]

Cosmic5 UCAR
 No obs: 54
 No OK: 54
 Conv 0.0 0.0
 Cost 0.0 0.0
 O-y 0.0 0.0
 Miss 0.0 0.0
 O-B 0.0 0.0
 NN ref 1.0 0.0 [1]

Cosmic6 UCAR
 No obs: 103
 No OK: 101
 Conv 0.0 0.0
 Cost 0.0 0.0
 O-y 0.0 0.0
 Miss 0.0 0.0
 O-B 0.0 0.0
 NN ref 1.0 0.0 [2]

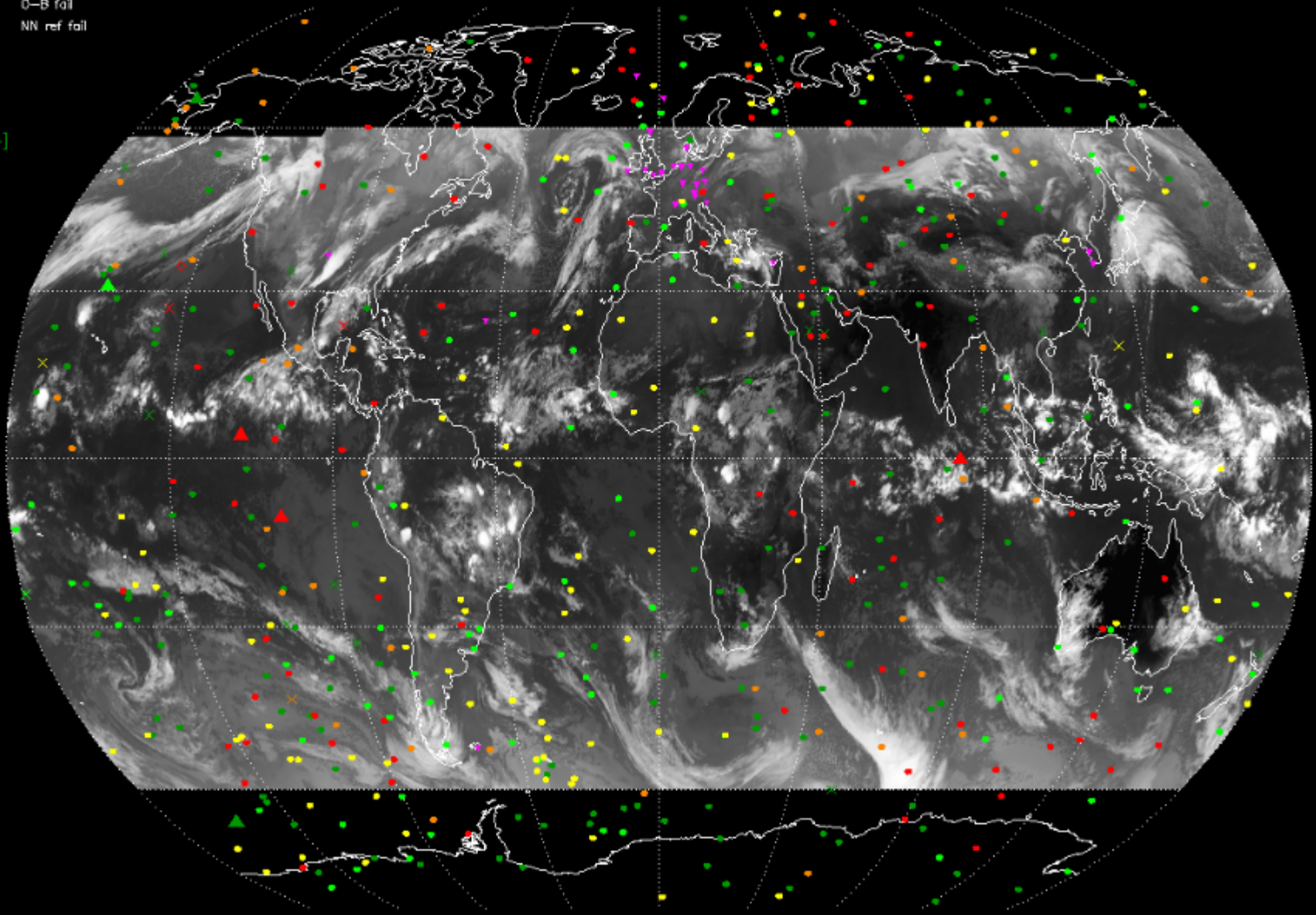

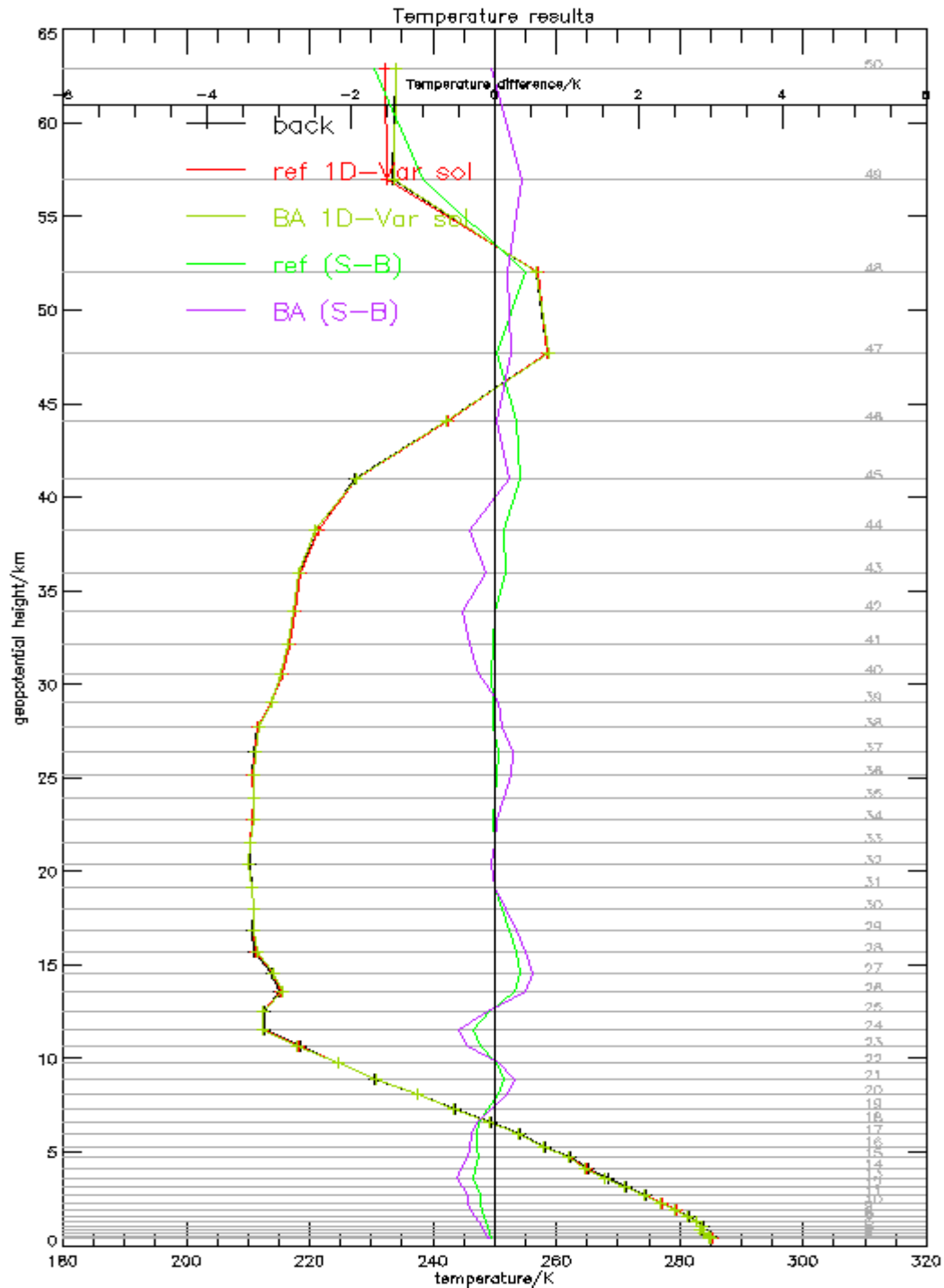



Outline of talk

- Introduction: requirements
- Current systems for processing observations
- Examples of monitoring
- Problems with current practice
- Future plans
- Summary

MetDB mergeback

- MetDB “mergeback” is the primary mechanism for storing qc and model associated data

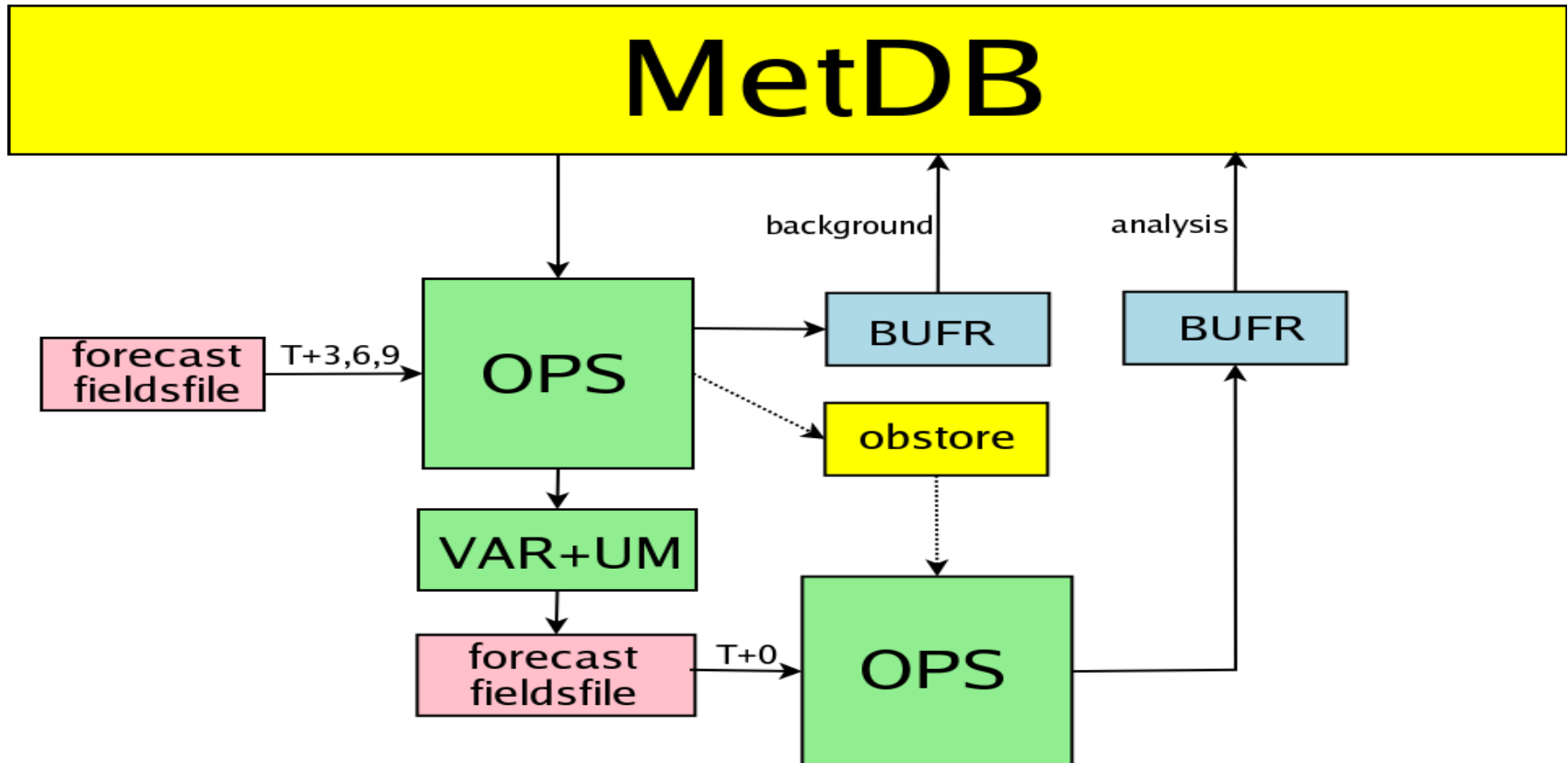



Problems with current practice (for monitoring)

- No capability for full operational monitoring techniques in trial suite environment
- Lack of linkage between observation processing and other assimilation diagnostics
- Generic monitoring techniques to deal with wide range of observation types preferable
- Many aspects automated, but some manual evaluation still needed
- And, in particular, the dependence on the MetDB:
 - Inconsistencies in observation processing for different applications
 - Stratification of results for investigations can be cumbersome
 - + technical →

MetDB structure

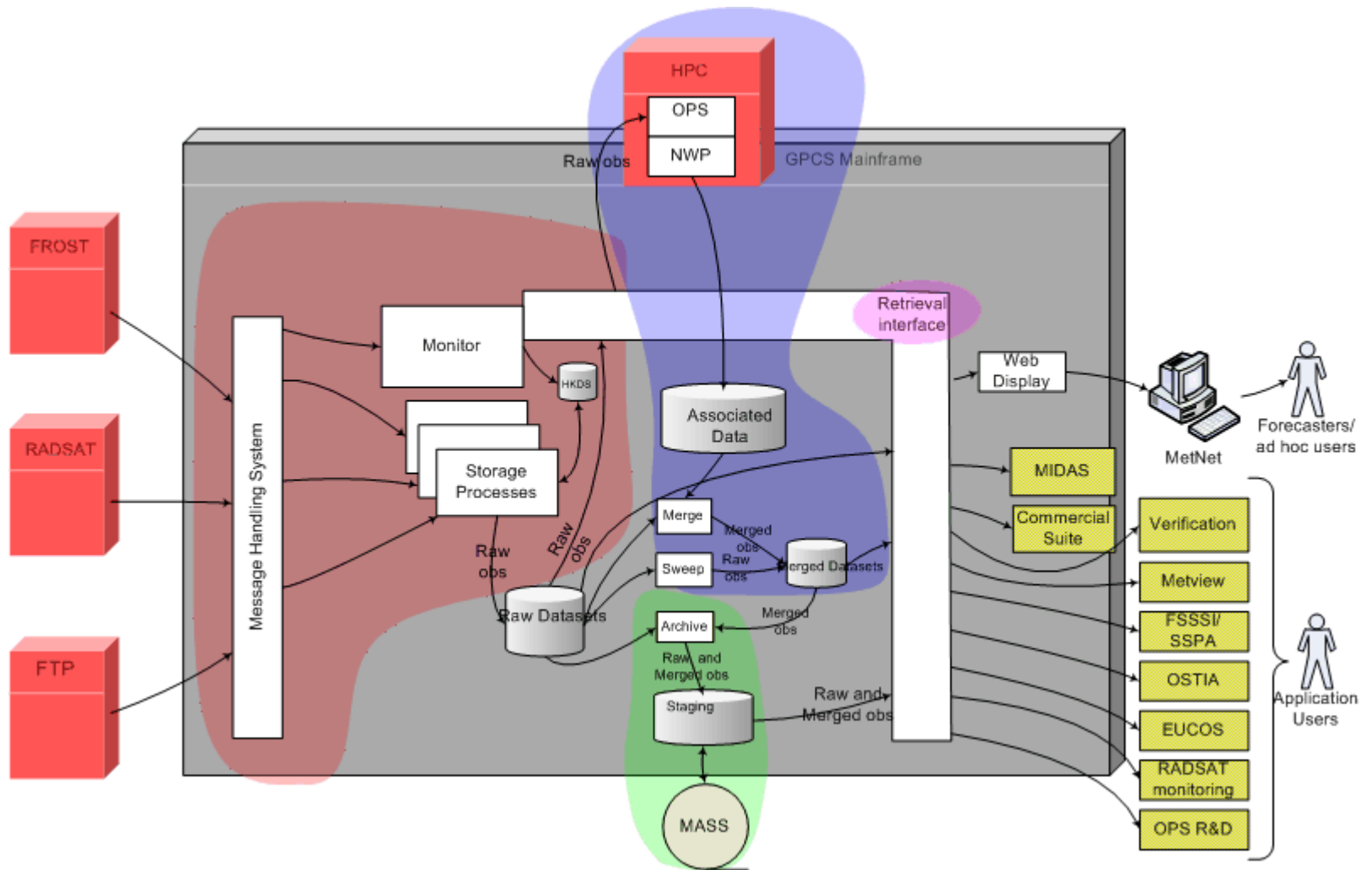



Problems with current practice (MetDB)

- Complexity of system
- Based on old 32-bit OS technology and communications (RPC) - some problems with address limits and reliability
- Relatively time-consuming to introduce new observation types
- Difficulties in maintaining consistency and reliability of observation retrievals
- Lack of full portability



Outline of talk

- Introduction: requirements
- Current systems for processing observations
- Examples of monitoring
- Problems with current practice
- **Future plans**
- Summary



Future plans with impacts on observation processing

- Adopt ECMWF's ODB and associated tools as replacement for MetDB mergeback system of monitoring observations
- Replacement of MetDB
- Sonde T/RH bias correction
- Adjoint sensitivity capability
- Variational QC
- [Verification pilot scheme]



Plans : ODB as replacement for MetDB monitoring

- Advantages in combining observation and assimilation data on hpc platform
- Allows for a more coherent approach to monitoring at Met Office, with pre-operational trialling capability
- Can make use of BoM's OPS/ODB integration
- Advantages of joint development
- Phased approach
 - Priority is to identify all current MetDB mergeback dependencies
 - Bespoke monitoring tasks can be migrated in slower time
- Simplifies MetDB replacement project



Met Office

ODB replacement - timescales

- **October 2009**
 - Identify requirements and benefits
 - Demonstrate capability with subset of observation types
- **March 2010**
 - Extend capability to all current observation types
 - Design archiving strategy
- **End 2010**
 - Roll out replacement system
- **Longer term**
 - New data types: e.g. radar
 - Integrate with MetDB replacement project (ODB as input too)
 - Much greater potential for increased collaboration with others



Proposed Set of Future Realtime Observation Services (MetDB replacement)

Principles

Breakdown into focussed services to address different specific requirements

All observations to be shared are 'published' to the Realtime Observation Data Management system

Observations for 'general use' retrieved via standard interfaces

Specialist interfaces to meet more specialist functions

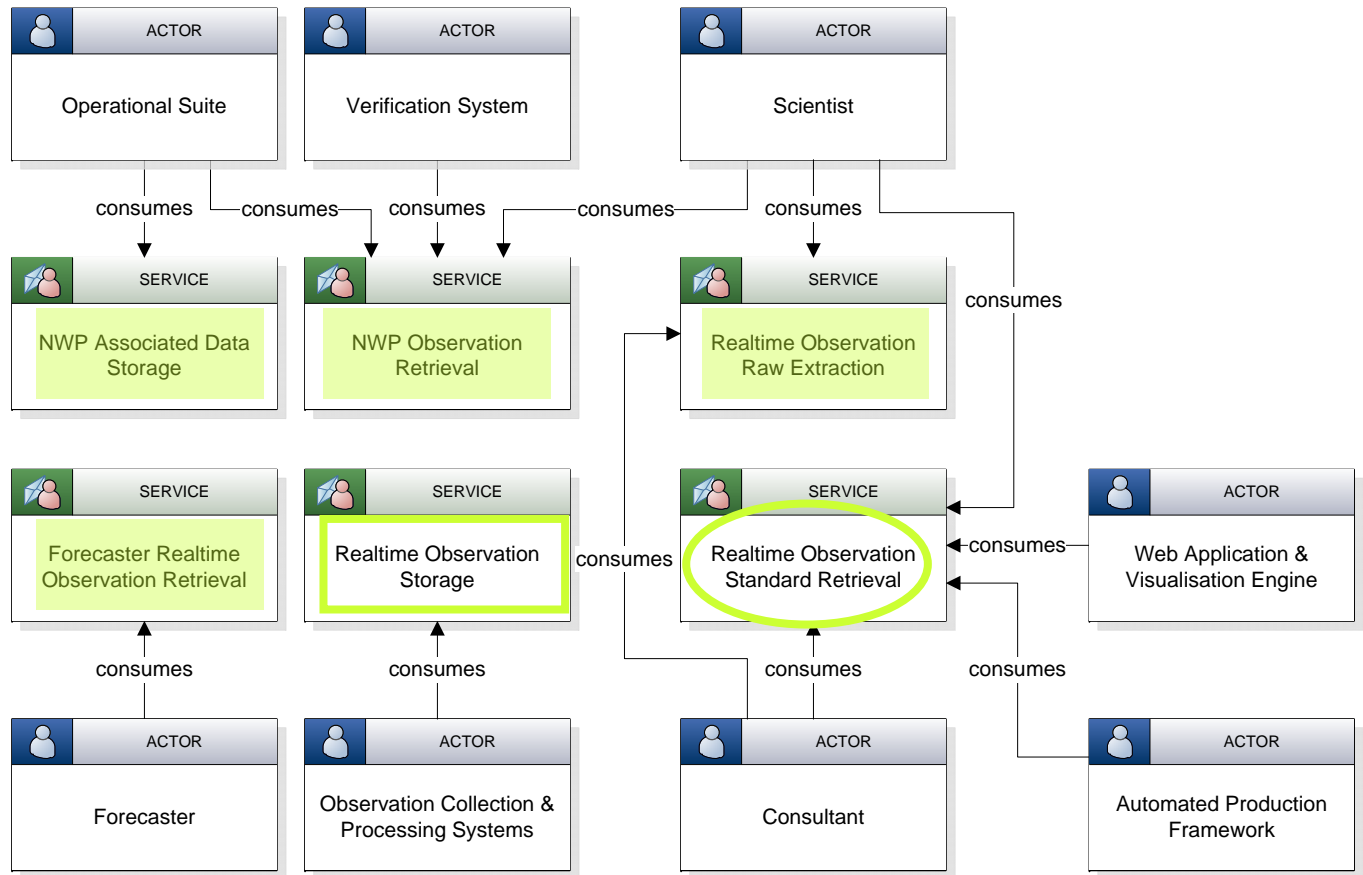



Proposed Technology Supporting Realtime Observation Services (MetDB replacement)

Archive

All data to be retained held here in unaltered form

Extraction likely to simply return whole files, as they were received, with access restricted

NWP Observation Service

'Closed' data management capability for observation & associated data used within NWP & Post-processing

Only required data are made available, but with more specialist functionality provided

Raw Data Handling

All data passes through here

Extraction likely to be simply return whole files, as they were received

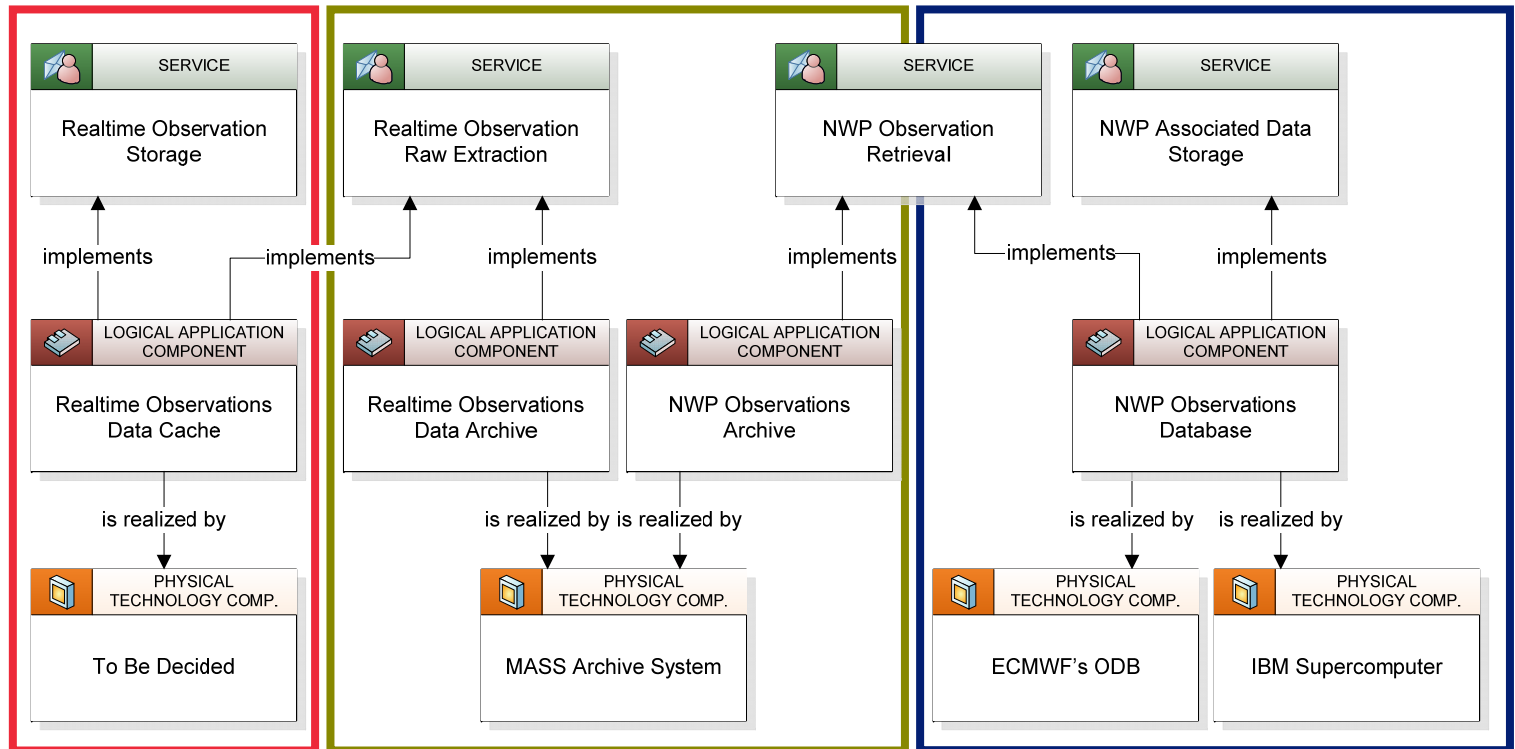



MetDB replacement

- Stage 1
 - Enhance existing internet-facing “Data Services” capability
 - Move to adopt ECMWF’s ODB (replace mergeback)
- Stage 2
 - Develop Realtime Observation Raw Data Cache
 - Decommission current MetDB
- Stage 3
 - Broaden to support the wider Environmental Data Management function (e.g. climatological observations, radar & satellite imagery, etc)



Future plans with impacts on observation processing

- Adopt ECMWF's ODB and associated tools as replacement for MetDB mergeback system of monitoring observations
- Replacement of MetDB
- Sonde T/RH bias correction
- Adjoint sensitivity capability
- Variational QC
- [Verification pilot scheme]

Summary

- Observation processing for data assimilation in global (and regional) models is generally efficient and versatile [though challenges remain with new observations, particularly at high resolution].
- However, this tends to lead to complex systems that benefit from a periodic refresh of software.
- Monitoring is important for improving both observations and NWP forecasts – with greater sophistication required to keep up with increasing volumes and complexity of data.
- The Met Office has plans to adopt the ODB for more of its monitoring functions, which will also expedite rationalisation of the key Met Office database for observations.



The End

ECMWF Met Operational Systems Workshop 2-6 Nov 2009

Rick Rawlins

Met Office UK

